



High performance LED Vaporproof fixture. A classic design with cutting edge LED technology. Comes with die cast guard and frosted globe.

Color: Natural

Weight: 5.8 lbs

**Project:**

**Type:**

**Prepared By:**

**Date:**

### Driver Info

Type	Constant Current
120V	0.25A
208V	0.14A
240V	0.13A
277V	0.11A
Input Watts	27.1W

### LED Info

Watts	26W
Color Temp	4900K (Cool)
Color Accuracy	68 CRI
L70 Lifespan	100,000 Hours
Lumens	2,004
Efficacy	73.9 lm/W

## Technical Specifications

### Compliance

#### UL Listed:

Suitable for wet locations as a downlight

#### IESNA LM-79 & LM-80 Testing:

RAB LED luminaires and LED components have been tested by an independent laboratory in accordance with IESNA LM-79 and LM-80.

### Performance

#### Lifespan:

100,000-Hour LED lifespan based on IES LM-80 results and TM-21 calculations

### Construction

#### Globes and Guards:

Vaporproof LEDs are compatible with RAB Globes and Guards

#### Cold Weather Starting:

Minimum starting temperature is -40°C (-40°F)

#### Ambient Temperature:

Suitable for use in up to 40°C (104°F)

#### Housing:

All die-cast aluminum construction

#### Gaskets:

High-temperature silicone

#### Finish:

Natural shot blasted aluminum

#### Mounting:

(3) 3/4" NPS conduit entry points

#### Guard and Globe:

Shot blasted guard with frosted globe

#### Green Technology:

Mercury and UV free. RoHS-compliant components.

### LED Characteristics

#### LED:

Multi-chip 26W high-output, long-life LED

#### Color Consistency:

7-step MacAdam Ellipse binning to achieve consistent fixture-to-fixture color

## Technical Specifications (continued)

### LED Characteristics

#### Color Stability:

LED color temperature is warranted to shift no more than 200K in color temperature over a 5-year period

#### Color Uniformity:

RAB's range of Correlated Color Temperature follows the guidelines of the American National Standard for Specifications for the Chromaticity of Solid State Lighting (SSL) Products, ANSI C38.377-2011.

### Other

#### Patents:

The design of the LVAPOR is protected by the following patents US pat. pending; D651738 CN ZL201230040341.3; ZL201130028360.X, TW pat. 101301367 MX 35699; pat. pending CA.

#### Warranty:

RAB warrants that our LED products will be free from defects in materials and workmanship for a period of five (5) years from the date of delivery to the end user, including coverage of light output, color stability, driver performance and fixture finish. RAB's warranty is subject to all terms and conditions found at [rablighting.com/warranty](http://rablighting.com/warranty).

### Buy American Act Compliance:

RAB values USA manufacturing! Upon request, RAB may be able to manufacture this product to be compliant with the Buy American Act (BAA). Please contact customer service to request a quote for the product to be made BAA compliant.

### Electrical

#### Driver:

Constant Current, 100V-277V, 50/60 Hz, 0.48 Amp, Power Factor 97.9%.

## Dimensions

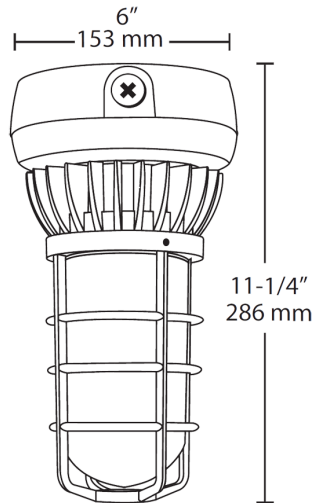

## Features

- Vaporproof LED Ceiling Mount
- Superior Thermal Management (Patent Pending)
- All Die-Cast Aluminum Construction
- 100,000-hour life based on LM-80 results and TM-21 calculations
- Thermal Shock-Resistant Frosted Glass Globe
- Traditional Look, Cutting-Edge Technology
- 5-Year, No-Compromise Warranty