

INSTRUCTIONS

ALED® FIELD-ADJUSTABLE INSTALLATION

RAB®

RAB Lighting is committed to creating high-quality, affordable, well-designed and energy-efficient LED lighting and controls that make it easy for electricians to install and end users to save energy. We'd love to hear your comments. Please call the Marketing Department at 888-RAB-1000 or email: marketing@rablighting.com



IMPORTANT

READ CAREFULLY BEFORE INSTALLING FIXTURE. RETAIN THESE INSTRUCTIONS FOR FUTURE REFERENCE.

RAB fixtures must be wired in accordance with the National Electrical Code and all applicable local codes. Proper grounding is required for safety. THIS PRODUCT MUST BE INSTALLED IN ACCORDANCE WITH THE APPLICABLE INSTALLATION CODE BY A PERSON FAMILIAR WITH THE CONSTRUCTION AND OPERATION OF THE PRODUCT AND THE HAZARDS INVOLVED.

WARNING: Make certain power is OFF before installing or maintaining fixture. No user serviceable parts inside.

CAUTION: For proper weatherproof function all gaskets must be seated properly and all screws inserted and tightened firmly.

MOUNTING TO POLE

For use with standard RAB pole drilling. See *Pole Drilling Pattern Detail (Fig. 5)*.

1. Place **Gasket** between the **Pole Mount Bracket** and drilled **Pole** as shown in Fig. 1. Line-up center hole of **Gasket** with center hole in the **Pole Drilling Pattern**.
2. Place **3/8-16 Bolt** (*provided*) from the **Pole Mount Bracket** through the top hole of the **Gasket** to the **Pole**. Use **Nut, Lockwasher** and **Washer** (*provided*) and tighten inside the **Pole**.
3. Loosen (2) **Door Screws** and open **Door** as shown in Fig. 1.
4. Loosen (1) **Cleat Screw**. Separate **Cleat/Door Assembly** from fixture. Set desired Color Temperature (*CCT*), Power (*W*) and/or Photocell ON/OFF position (*see Field Adjustment instructions Fig. 3*).
5. Secure **Cleat/Door Assembly** to the **Pole Mount Bracket** using (2) **Stainless Steel Screws** (*provided*).
6. Slide fixture on **Cleat/Door Assembly** and secure using (1) **Cleat Screw**.
7. Make the necessary wiring connections and knot the wires for strain relief. Wire the fixture using UL listed wire connectors according to NEC and local codes. See wiring diagram, Fig. 6, 7.
8. Install the **Pole Cap**.

FIG. 1

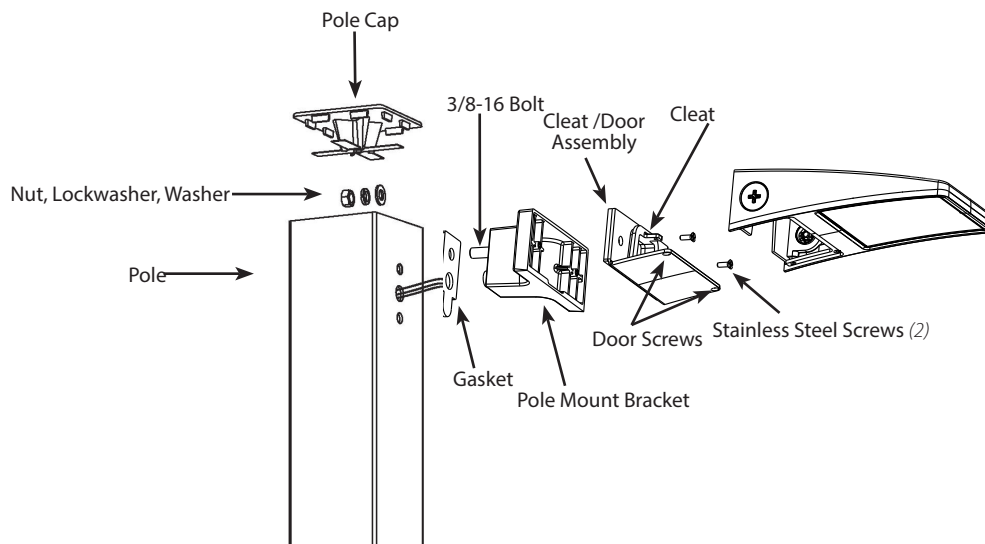

INSTRUCTIONS

ALED® FIELD-ADJUSTABLE INSTALLATION



RAB Lighting is committed to creating high-quality, affordable, well-designed and energy-efficient LED lighting and controls that make it easy for electricians to install and end users to save energy. We'd love to hear your comments. Please call the Marketing Department at 888-RAB-1000 or email: marketing@rablighting.com

ROUND POLE ADAPTOR ACCESSORY

For use with standard RAB Pole Drilling Pattern Detail.

1. Drill **Round Pole** using the dimensions shown in **Pole Drilling Pattern Detail** (Fig. 5).
2. Trim **Adaptor Gasket** supplied with ALED.
3. 3/8-16 **Bolt** may not be long enough as originally supplied with ALED. A longer **Fixture Bolt** is supplied with the RPA LED kits.
4. Place **Round Pole Adaptor** (sold separately) and **RPA Gasket** (sold separately) between the **Pole Mount Bracket** and drilled Pole as shown in Fig. 2. Line up top holes of the **Gaskets** and **Round Pole Adaptor** with top hole in the **Pole Drilling Pattern**.
5. Place 3/8-16 **Bolt** from the ALED through the top hole of the RPA and **Gaskets** to the **Round Pole**. Use **Nut**, **Lockwasher** and **Washer** and tighten inside the Pole.
6. Refer to **Mounting to Pole** section above #3 through #8 to complete the installation.

FIG. 2

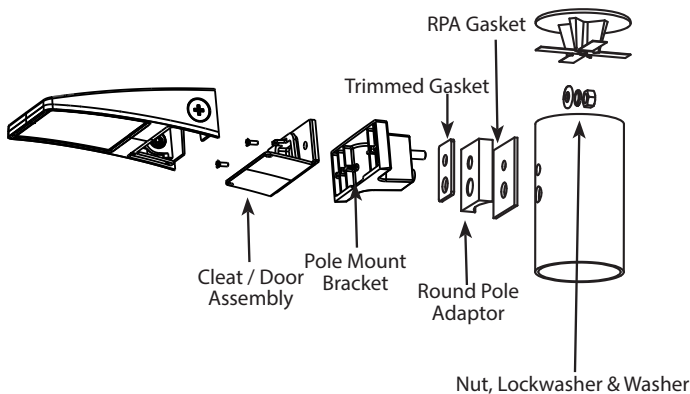

FIELD ADJUSTMENT

Photocell Operation:

This product is equipped with a photocell. **Photocell factory setting is set to the "OFF" position.** Should you wish to enable the Photocell "ON" feature slide the center switch to the "ON" position (Fig 3 & 4). ***If the Photocell is set to the "ON" position and it is daylight it may take up to 60-seconds for the light to turn off.***

Color Temperature (CCT) Selection:

This product is equipped with 3000K, 4000K or 5000K (CCT) **Color Temperature** selection. For maximum light output use the 4000K **Color Temperature**.

Power (Wattage) Selection:

This product is equipped with power output selection.

ALEDXXS 13/10/6W

ALEDXS 32/24/16W

Follow instructions below to change **Color Temperature (CCT)** **Power (W)** and/or **Photocell** operation from factory settings.

Factory Settings: ALEDXXS 10W / 4000K / Photocell/OFF

ALEDXS 24W / 4000K / Photocell/OFF

1. Locate the **Selector Switches** inside of housing as shown in Fig. 3.
2. Select **Color Temperature (CCT)**, **Power (W)** and/or **Photocell ON/OFF** function by sliding the respective switch to the desired setting.

FIG. 3

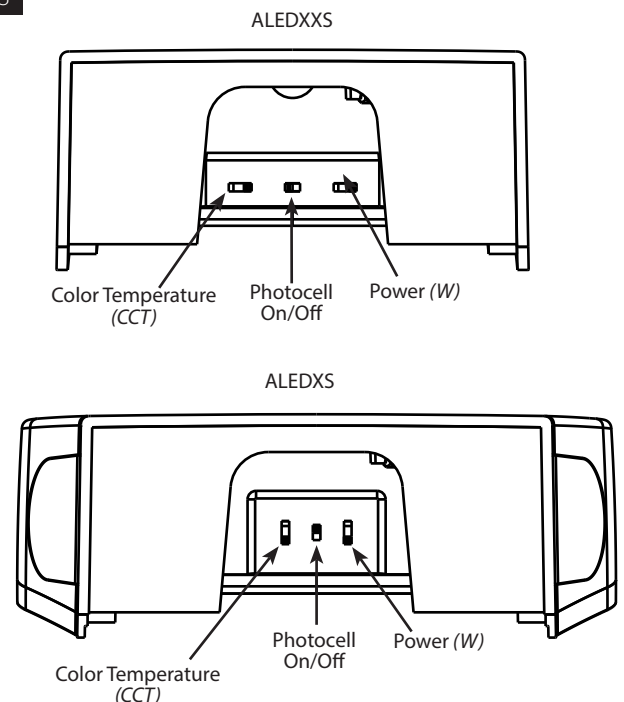

INSTRUCTIONS

ALED® FIELD-ADJUSTABLE INSTALLATION



RAB Lighting is committed to creating high-quality, affordable, well-designed and energy-efficient LED lighting and controls that make it easy for electricians to install and end users to save energy. We'd love to hear your comments. Please call the Marketing Department at 888-RAB-1000 or email: marketing@rablighting.com

LCBS/MVS WIRING (AVAILABLE FOR ALEDXS SIZE ONLY)

Universal voltage driver permits operation at 120V through 277V 50 or 60 Hz. For **LCBS/MVS** wiring follow the wiring directions as shown in Fig. 4.

1. Connect the black fixture lead to the **LINE** supply lead.
2. Connect the white fixture lead to the **COMMON** supply lead.
3. Connect the **GROUND** wire from fixture to supply ground.
4. Connect the pink fixture lead to the pink **LCBS/MVS** lead.
5. Connect the purple/white **MVS+** fixture lead to the purple **LCBS/MVS** lead.
6. Connect the black/white fixture lead to the black/white **LCBS/MVS** lead.
7. Cap the purple fixture lead if present. DO NOT connect.

NOTE: Do not connect DIM V+ (purple)/ DIM V- (pink) to line voltage or supply ground.

Fig: 4

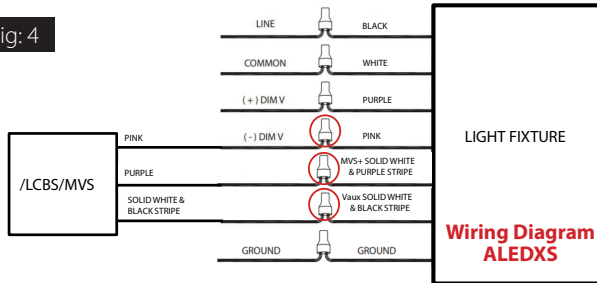

0-10V DIMMABLE WIRING

Universal voltage driver permits operation at 120V through 277V 50 or 60 Hz. For 0-10V dimming follow the wiring directions as shown in Fig. 6 and 7.

1. Connect the black fixture lead to the **LINE** supply lead.
2. Connect the white fixture lead to the **COMMON** supply lead.
3. Connect the **GROUND** wire from fixture to supply ground.
4. Connect the purple fixture lead to the (V+) DIM lead.
5. Connect the pink fixture lead to the (V-) DIM lead.
6. Cap the Purple/White and Black/White fixture leads. DO NOT connect.

NOTE: Do not connect DIM V+ (purple)/ DIM V- (pink) to line voltage or supply ground.

Fig: 6

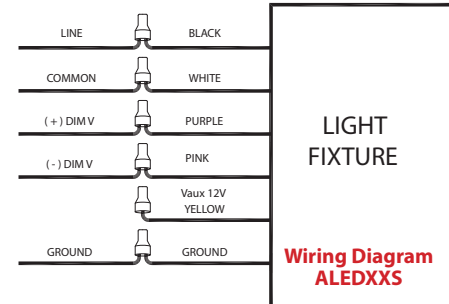

POLE DRILLING PATTERN DETAIL

For non-RAB poles use these dimensions to drill the pole. This template is not to scale. Please use measurements shown. For RPA and ALED mounting bottom hole is not necessary.

FIG. 5

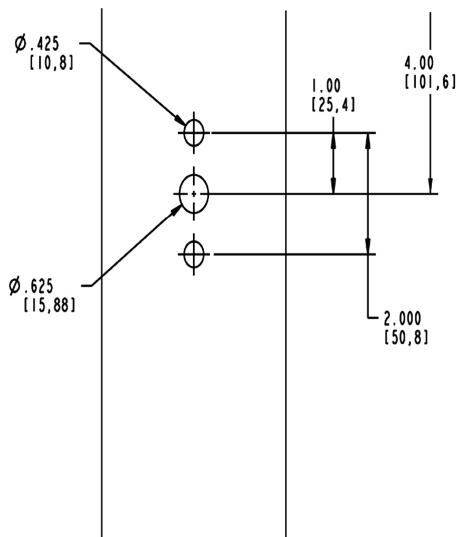
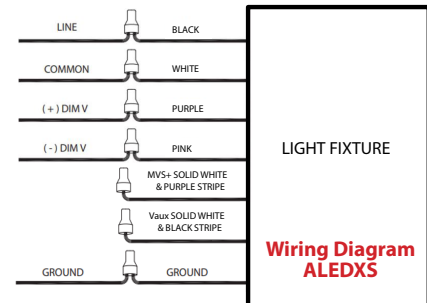

Fig: 7



INSTRUCTIONS

ALED® FIELD-ADJUSTABLE INSTALLATION



RAB Lighting is committed to creating high-quality, affordable, well-designed and energy-efficient LED lighting and controls that make it easy for electricians to install and end users to save energy. We'd love to hear your comments. Please call the Marketing Department at 888-RAB-1000 or email: marketing@rablighting.com

CLEANING & MAINTENANCE

CAUTION: Be sure fixture temperature is cool enough to touch. Do not clean or maintain while fixture is energized.

1. Clean lens with non-abrasive glass cleaning solution.
2. Do not open the fixture to clean the LED. Do not touch the LED.

TROUBLESHOOTING

1. Check that the line voltage at the fixture is correct. Refer to wiring directions.
2. Is the fixture grounded properly?
3. Is the photocell, if used, functioning properly?

***Note:** These instructions do not cover all details or variations in equipment nor do they provide for every possible situation during installation, operation or maintenance.*



© 2025 RAB LIGHTING Inc.

Easy Answers

rablighting.com
Visit our website for product info

Tech Help Line
Call our experts: 888 722-1000

e-mail
Answered promptly - tech@rablighting.com

Free Lighting Layouts
Answered online or by request

ALEDXXS/ALEDXS - IN - 0325
P-100674

RAB WARRANTY: RAB's warranty is subject to all terms and conditions found at rablighting.com/warranty.